

TwinPower Turbine® High Speed Handpieces

Thinking ahead. Focused on life.





Thinking ahead.



Focused on life.



Double-impeller Technology

Provides class leading, high-powered performance (up to 25 W) while delivering constantly balanced torque.

Ceramic Ball Bearings

40% lighter and 3 times harder than conventional bearings, they offer an extended turbine life, reduced operation noise, and less vibration.

Quick-stop Brake System

Rapid braking for optimal operator and patient safety.

Unique Zero Drawback Technology

Prevents the intake of aerosol and other particles when it is stopped.

Radial Air Bypass

Minimizes patient discomfort by displacing exhaust air away from the preparation area.

Quiet Operation

Advanced fluid dynamics enables extremely quiet, high speed instrumentation.

Compact Head

Offers enhanced maneuverability and superior access.

Glass Rod Optics

Highly focused and stable illumination – 25,000 LUX.

Flexible Coupling Options

Direct connection to various commonly used couplings.

Push-button Chuck

Simple to operate, this high-precision function ensures safe attachment to the preparation instrument.

Easy Cartridge Replacement

Capsule-type cartridge rotor allows for simple exchange when required.

TwinPower Turbine High Speed Handpieces Equipping You with Numerous Advantages

Not all features available on all handpiece models.



TwinPower Turbine Design

With Morita's unique design, TwinPower forms a perfect balance of efficiency and operator comfort. Light, compact, convenient, and highly functional – in a word: perfection.

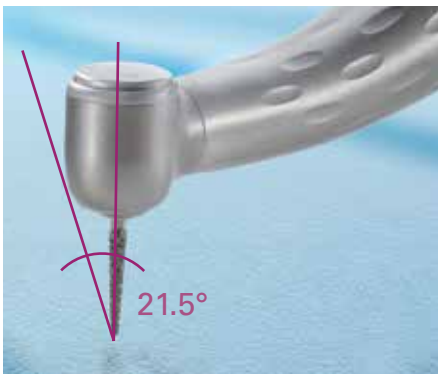

The angle of the head provides greater visibility

Well-balanced, ergonomic design

The compact and lightweight design of TwinPower is extremely comfortable to work with – even over extended periods of use. Weighing as little as 48 grams, fatigue of the operator's hand, wrist, and fingers is significantly reduced.

Ideal angulation

The practical 15° angle of TwinPower's standard head handpiece enables you to easily maneuver around the various areas of the oral cavity. The head is also perfectly angled at 21.5° to enhance alignment of the bur shaft with the tooth's axis.

New grip design and surface treatment

TwinPower features a newly designed grip, which enables a relaxed hold of the handpiece. The unique ceramic coating treatment offers up to 30% greater friction forces, improving grip and durability throughout multiple sterilization cycles.

TwinPower features the all new double-impeller technology – a truly unique engineering advancement.

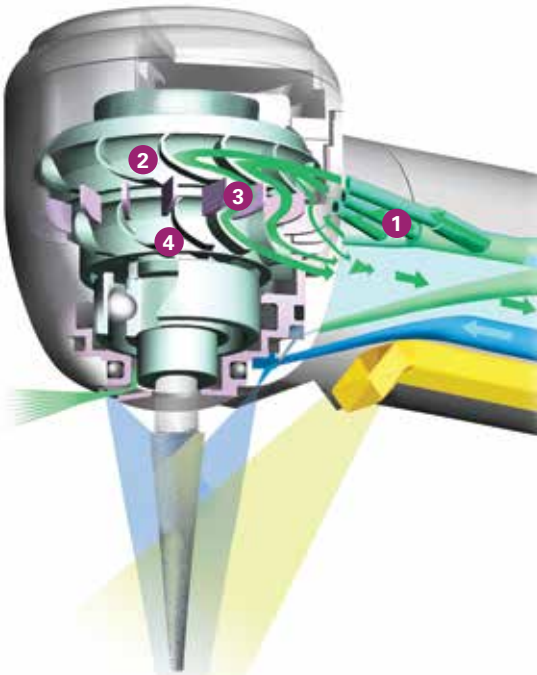

TwinPower's design and operational concept

The air from the drive air nozzles (1) powers the primary impeller (2). The exhaust air is directed through fixed fins (3) to power the secondary impeller (4). The operational result is a more powerful, constant torque and controlled speed, even under load.

- 1 Three drive air nozzles
- 2 Primary impeller
- 3 Fixed fins to direct the exhaust air
- 4 Secondary impeller

Quiet operation

Advanced fluid dynamics reduces high-pitch noise typically found in high speed handpieces in the 6 - 7 kHz range. The result is quieter operation for both the dental team and patients.

Greater precision through higher torque

The unique double-impeller technology of TwinPower offers high continuous torque and improved stability, even under high-load conditions. The consistent cutting power allows you to prepare with far greater precision.

Advanced Engineering with Double-impeller Technology

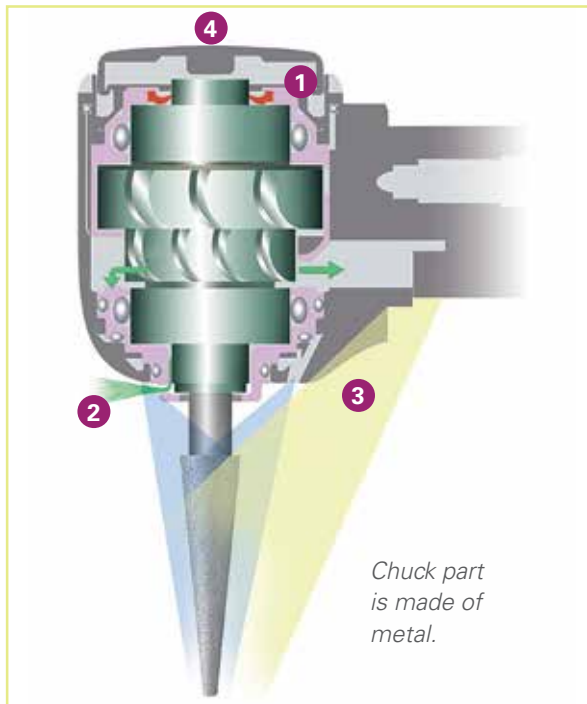

1 Rapid stop brake ring

For enhanced preparation safety, the TwinPower series features a unique quick stop brake ring that stops the turbine within 2 seconds. It also reduces the risk of contaminated aerosol drawback flow and prolongs the life span of the bearings.

2 Radial air bypass

Unique and new – the air is dispersed sideways via the radial air bypass to minimize the patient's discomfort. Usually this discomfort occurs from a vertical cold air stream on the preparation area from other high speed handpieces.

3 Glass rod optics

Autoclave tested, glass rod optics guide for stable brightness of 25,000 LUX.

4 Push-button chuck

The push-button chuck is simple to operate. This high-precision function ensures safe attachment to the preparation instrument while providing high-level durability for heavy-load applications.

Quick-stop brake for preparation safety

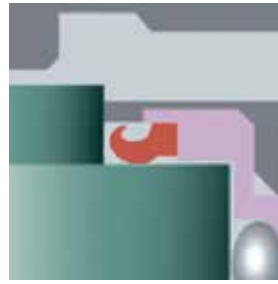
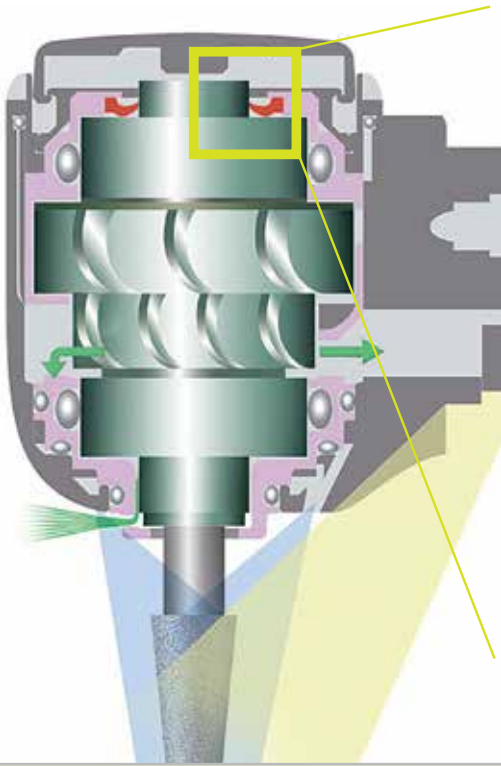

During rotation, the uniquely designed rubber brake ring in TwinPower is pulled away from the turbine axis

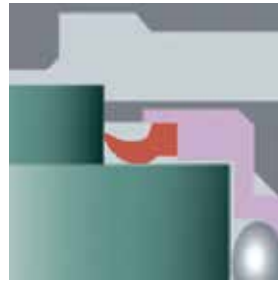

During braking, the rubber brake ring rubs against the turbine axis, stopping it significantly faster

Rapid braking poses a particular challenge for ball bearing high speed handpieces. Due to the unique rubber brake ring in the TwinPower quick-stop system, it is now possible to rapidly stop the turbine within 2 seconds – allowing for safer and more efficient preparations.

Zero Drawback Through Innovative Fluid Dynamics

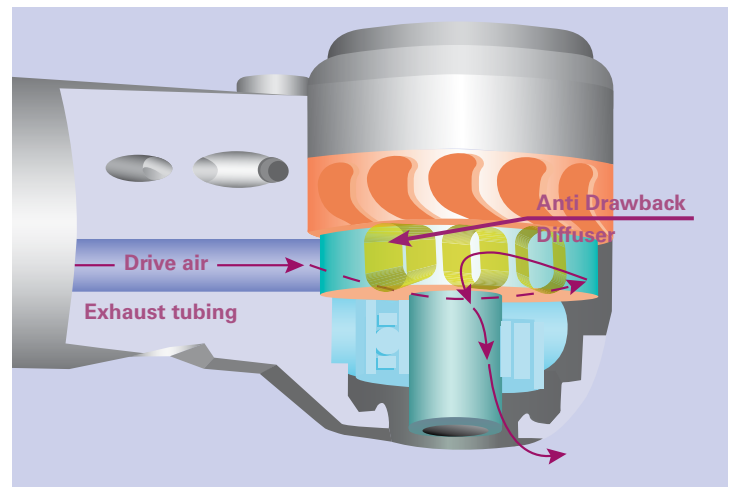
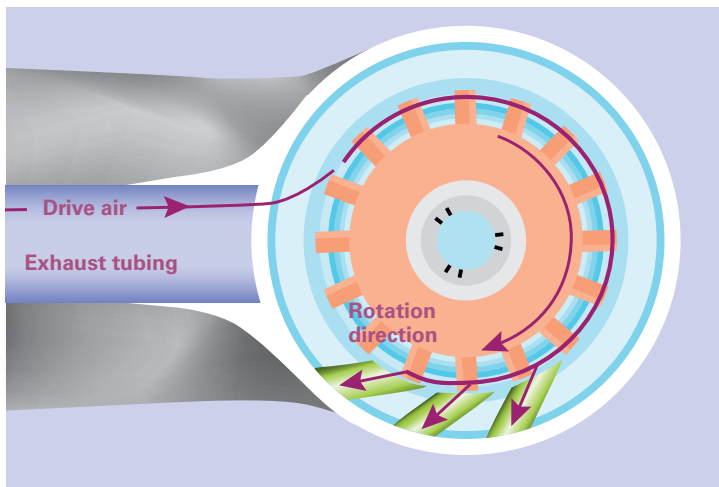

Zero drawback

1. Drive air flows into an Anti Drawback Diffuser within the capsule. Air in the diffuser is pressurized through centrifugal force created by the impeller rotation.
2. Through the centrifugal force and rotation of the impeller, air continues to flow into the diffuser and remains pressurized even after drive air is stopped.
3. The pressurized air in the diffuser is released to the outside at the bottom of the head.
4. Exhaust air is also directed over the diffuser through rotation and is released at the bottom of the head.
5. The pressurized air in the diffuser prevents depressurization in the head, thus enabling true zero drawback.

Extremely Powerful, Balanced, and Constant Torque

Balanced, constant torque is required to achieve exceptional, smooth tooth preparations. The unique functional design of TwinPower has delivered this balanced, constant torque for the first time. Morita has turned this concept into reality.



TwinPower rotor

TwinPower's double-impeller technology features 36 impeller blades. Three drive air nozzles power the blades. Even when the blade angle changes, the drive air continues to be captured by multiple blades, generating superior power and constant torque, thus creating no vibration.



Conventional rotor

Conventional high speed rotors are typically equipped with 8 impeller blades and 1 drive air nozzle. Depending on the angle of the blade, the drive air is not directly captured by the blade, resulting in weak torque phases.

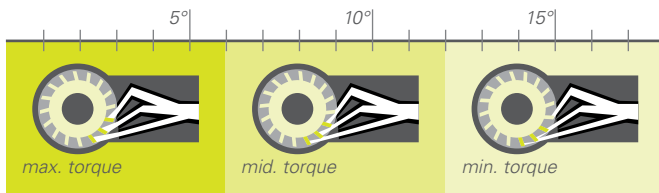
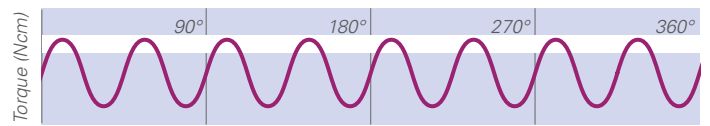
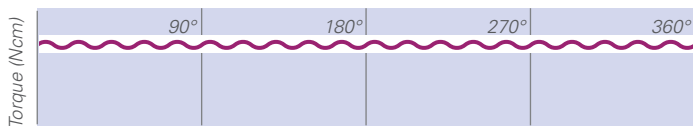

Blades angle (degrees)

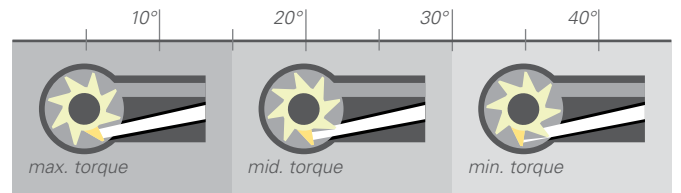

Blades angle (degrees)

Compact and powerful design

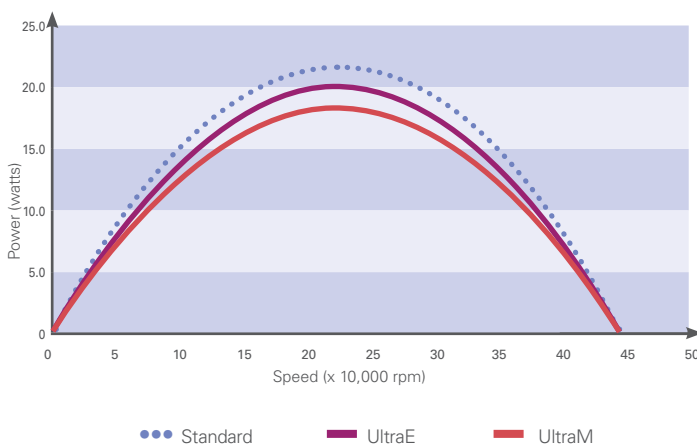

Thanks to double-impeller technology, the turbines of the TwinPower series are extremely powerful and can be used for both ceramic and metal prosthetics.

Graph represents the range of power offered by various TwinPower Turbine handpieces

TwinPower Turbine High Torque

New!



The most powerful model yet

At times, standard turbines are unable to meet high demand preparations with performance dropping off under heavy loads. The TwinPower Turbine High Torque model is the solution.

The most powerful of the product line, it delivers the highest level of cutting efficiency. With a head diameter of 12 mm and a height of just 13.2 mm, visibility is excellent and users have noted the head size is relatively small especially compared to other high torque models on the market.

Worldwide, the high torque model is a best-seller due to its solid performance and reliability. For large preparations, or simply more power, this model is an exceptional choice.

- Morita's most powerful handpiece
- High torque head competitively small
- Head size: 12 mm (diameter) x 13.2 mm (height)
- 2-year warranty

TwinPower Turbine Standard



The original, high-powered model

The Standard model is an excellent handpiece for everyday use. It provides a balance of power, access, and ergonomics. With high torque and up to 22 watts of power, the standard head ensures a constant, steady removal rate for precise and efficient preparations.

At the same time, an ergonomic design helps ensure pleasant working conditions. The standard model weighs as little as 48 grams. Its compact head offers enhanced maneuverability and access, while glass rod optics provide focused and stable illumination.

Clinically evaluated by several institutions, the Standard model has earned high marks for its fit to hand ergonomics, balance, visibility, power output, and braking ability.

- Up to 22 watts of power
- Head size: 10.5 mm (diameter) x 13.2 mm (height)
- 15° head angle allows for easy maneuverability within the oral cavity
- 2-year warranty



TwinPower Turbine Ultra Series Powerful Mini Handpieces

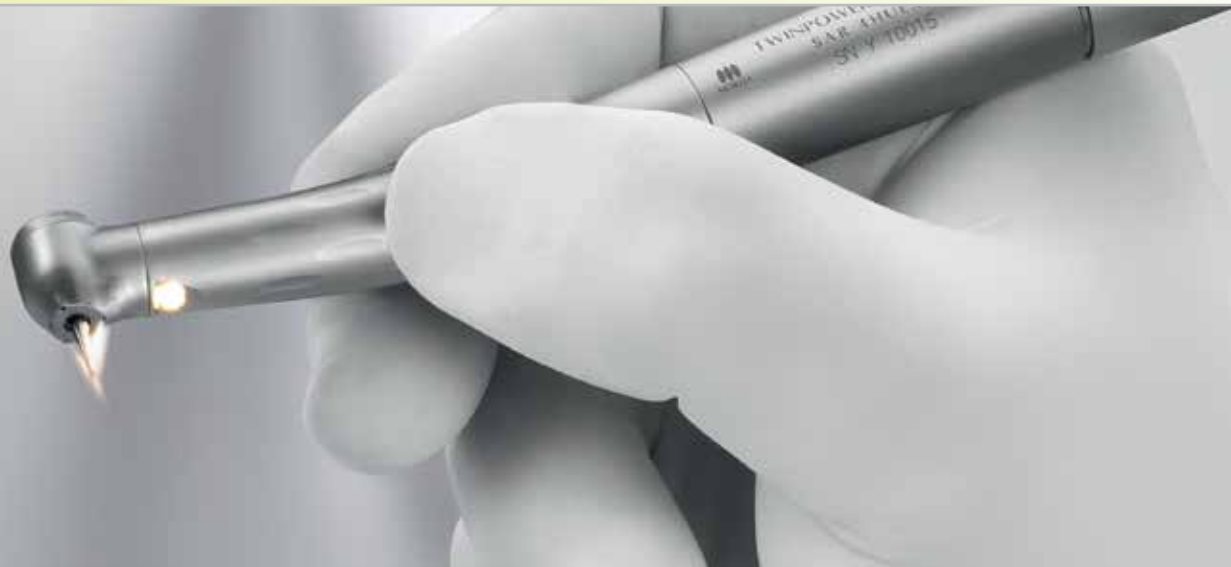

The Ultra Series includes the UltraM and UltraE

The TwinPower Turbine Ultra Series offers excellent cutting ability with smooth, chatter-free revolutions. A compact head design allows for exceptional posterior access and offers improved views with a mirror or microscope. Although they are 'mini' handpieces, clinician reviews have noted this series is powerful enough for everyday tooth preparation.

- Twice as powerful as other popular mini handpieces
- Compact design offers exceptional posterior access
- Improved views with a mirror or microscope
- More comfortable for patients
- 2-year warranty



The UltraM head is approximately 30% smaller than a TwinPower Turbine standard head. This gives the dentist a much better view of the treatment area. The UltraM head accepts a standard bur up to 20 mm in length. The usable portion of the bur (the part extending out of the head) is the same as that of a standard head.

Head type comparison

UltraM

UltraM delivers 18 watts, twice the power of some other popular mini handpieces, and offers an extremely compact head height for exceptional posterior access.

Accepts burs up to 20 mm.

UltraE

UltraE is a bit larger and more powerful at 20 watts, but still offers a compact head that improves the clinician's view when using a mirror or microscope.

Accepts standard burs.

Ultra Series – Improved Access and Visibility

Case 1. Pulp Chamber Opening

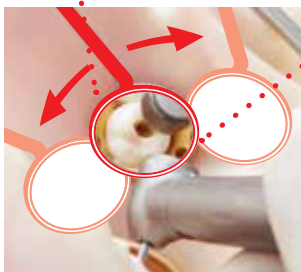

The UltraE head facilitates an improved view with a mirror or a microscope. The bur can easily be seen while accessing the pulp chamber. The small head allows for improved mirror positioning and better vision.



When using a standard sized head, the bur must be slanted for visibility which results in removal of more tooth structure than necessary.

Case 2. Molar Caries Preparation

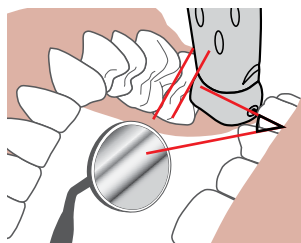

With UltraM, the bur can be held upright for use on molars (including wisdom teeth) or for patients who have limited opening.

The bur must be slanted with a standard head to gain access which leads to excessive drilling of the tooth structure. The mirror is placed to the side of the handpiece head and gets wet resulting in poor visibility.

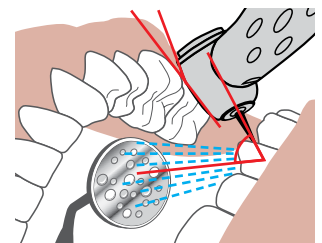

More Comfortable for Patients

Case 3. Posterior Occlusal Surface Treatment



UltraM (PAR-4HUMX-O)

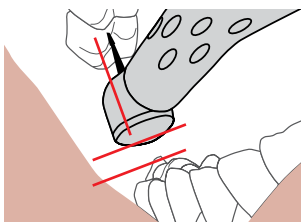

The UltraM head is more comfortable for patients and offers better access in the posterior region. It is especially helpful on the occlusal surface when the patient has limited opening.



Standard (PAR-4HEX-O)

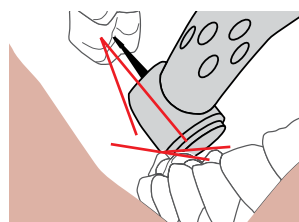

A standard sized head strikes opposing teeth in the treatment area. The sensation of this can be stressful and uncomfortable for patients.

Case 4. Posterior Caries Treatment



UltraM (PAR-4HUMX-O)

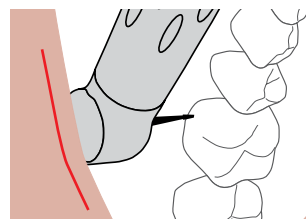

The handpiece head may be placed perpendicular to the tooth even in the posterior region. The labial and buccal gingiva do not prevent this due to the small head size of UltraM.



Standard (PAR-4HEX-O)

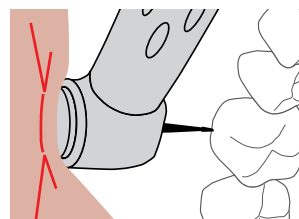

A standard size head presses up against the labial and buccal gingiva, which can be unpleasant for the patient.

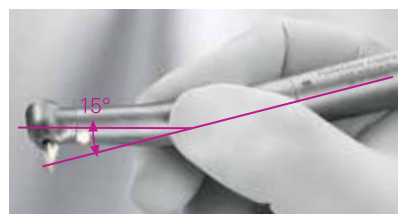

15° head angle

This is the ideal angle to hold the bur parallel to the tooth axis when resting your little finger on a tooth.

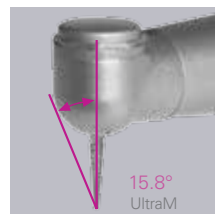

Wide field of view

A compact head leaves a wide field of view in line with the axis of the tooth. The dentist can see the tip of the bur during procedures. (shown with 19 mm bur)



TwinPower Turbine 45 Applications in Surgery, Periodontics, and Endodontics

TwinPower Turbine 45 offers maximum access and visibility with a 45° angle and an overall head size smaller than competitive units. Extremely powerful, it delivers up to 20 watts for smooth, efficient cutting.

Rear-facing exhaust vents direct air flow away from the surgical site for patient protection. With zero drawback in the air line, TwinPower also provides excellent contamination control, especially important in surgical procedures such as sectioning of 3rd molars.

- Maximum access and visibility with compact, 45° head
- Safe, rear-facing exhaust vents
- High torque; up to 20 watts of power
- Excellent contamination control with zero drawback
- 2-year warranty

TwinPower Turbine 45 is also available in a Non-Optic version.



TwinPower Turbine 45 Non-Optic

TwinPower Turbine 45 is one of the most powerful 45° handpieces available.

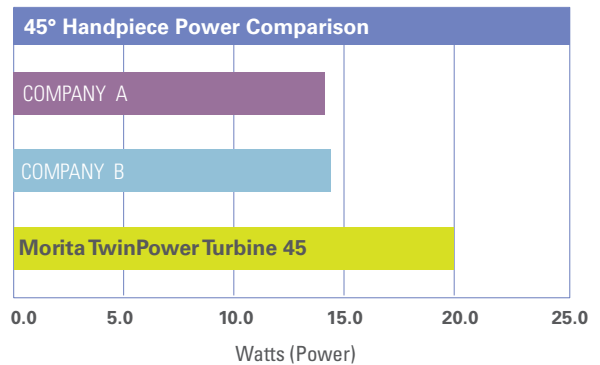

Exhaust vents direct the air flow away from the work site – an important design for patient safety during surgical procedures.

TwinPower Turbine Basic



TwinPower Turbine Basic Series

TwinPower Turbine Basic handpieces offer several features of the original product line, above and beyond those in their class. Common features include double-impeller rotor design, ceramic bearings, zero drawback in the air line, and rapid braking technology. As a more economical option, Basic Series handpieces offer a chrome body, 4-hole connection, no fiber optics, and a 1-year warranty.

TwinPower Turbine Basic



- 22 watts of power (equal to standard head)
- Chrome body
- Lightweight (45 grams)
- 4-hole connection
- 1-year warranty

TwinPower Turbine 45 Basic



- 20 watts of power (equal to standard 45)
- Chrome body
- Compact, 45° head
- Rear-facing exhaust vents
- 4-hole connection
- 1-year warranty

TwinPower Turbine Product Line

TwinPower Turbine High Torque

- Head Diameter: 12 mm
- Head Height: 13.2 mm



The new TwinPower Turbine high torque model is the most powerful of the product line. It delivers superior cutting efficiency and reduced preparation time.

TwinPower Turbine Standard

- Head Diameter: 10.5 mm
- Head Height: 13.2 mm



The TwinPower Turbine standard model offers 22 watts of smooth cutting power. Clinically evaluated by several institutions, TwinPower has earned high marks for its fit to hand ergonomics, balance, visibility, power output, and braking ability.

TwinPower Turbine UltraE

- Head Diameter: 9 mm
- Head Height: 12.7 mm



UltraE (mini) is slightly taller than UltraM and more powerful at 20 watts, but still offers a compact head that improves the clinician's view when using a mirror or microscope.

TwinPower Turbine UltraM

- Head Diameter: 9 mm
- Head Height: 10.6 mm



UltraM (mini) delivers 18 watts, twice the power of other popular mini handpieces. With the shortest head height, it offers exceptional posterior access.

TwinPower Turbine 45

- Head Diameter: 10.5 mm
- Head Height: 13.2 mm



The TwinPower Turbine 45 model offers maximum access and visibility with a 45° angle and an overall head size smaller than competitive units. Rear-facing exhaust vents direct air flow away from the surgical site for patient protection.

TwinPower Turbine 45 Non-Optic

- Head Diameter: 10.5 mm
- Head Height: 13.2 mm



The TwinPower Turbine 45 Non-Optic offers the same features as the standard 45, but without optics.

TwinPower Turbine Basic

- Head Diameter: 10.5 mm
- Head Height: 13.2 mm



The TwinPower Turbine Basic includes several features of the original TwinPower product line at a very economical price. It offers a 4-hole connection and chrome body.

TwinPower Turbine 45 Basic













- Head Diameter: 10.5 mm
- Head Height: 13.2 mm



The TwinPower Turbine 45 Basic offers several features of the standard 45 including rear-facing exhaust vents. As a more economical version, it has a 4-hole connection and a chrome body.

TwinPower Couplings – Total Compatibility

TwinPower Turbine offers several coupling options compatible with 4-hole, 5-hole, or 6-pin connections. Each of these coupling options feature an extremely smooth 360° rotation and quick disconnect for ease of use.











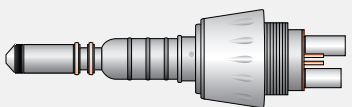

| TwinPower Morita Coupling Options | | (tubing side) |
|---|--|--|
|  | <p>CP4-LD (with LED light)</p> <ul style="list-style-type: none"> Compatible with 6-pin connection ISO 9168 Type 3 (formerly Type C[†]) Non-retractive valve |  <p>6-Pin Connection</p> |
|  | <p>CP4-W-LD (water adjustment & LED light)</p> <ul style="list-style-type: none"> Compatible with 6-pin connection ISO 9168 Type 3 (formerly Type C[†]) Non-retractive valve Water adjustment valve |  <p>6-Pin Connection</p> |
|  | <p>CP4-O (with light)</p> <ul style="list-style-type: none"> Compatible with 6-pin connection ISO 9168 Type 3 (formerly Type C[†]) Non-retractive valve |  <p>6-Pin Connection</p> |
|  | <p>CP4-WO (with water adjustment & light)</p> <ul style="list-style-type: none"> Compatible with 6-pin connection ISO 9168 Type 3 (formerly Type C[†]) Non-retractive valve Water adjustment valve |  <p>6-Pin Connection</p> |
|  | <p>CP4 (without light)</p> <ul style="list-style-type: none"> Compatible with 4-hole connection ISO 9168 Type 3 (formerly Type C[†]) Non-retractive valve |  <p>4-Hole Connection</p> |
|  | <p>CP5-O (with optics)</p> <ul style="list-style-type: none"> Compatible with 5-hole connection ISO 9168 Type 2 (formerly Type B[†]) Use with standard fiber optic tubing Non-retractive valve |  <p>5-Hole Connection (with Optics)</p> |

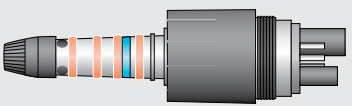
[†] ISO 9168 - Hose connectors for air driven dental handpieces was revised July 1, 2009. The type designation of handpiece joints was changed from letters to numbers.

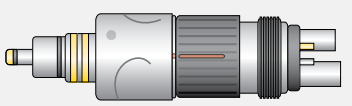

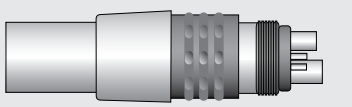
TwinPower Turbine High Speed Handpieces

Total Versatility

TwinPower can be connected to various commonly used couplings.

| | | | |
|---|--|---|---|
|  |  | TwinPower Morita | High Torque Standard UltraE UltraM 45° & 45° Non-Optic |
|  |  | KaVo® MULTiflex® LUX* | High Torque Standard UltraE UltraM 45° & 45° Non-Optic |
|  |  | Sirona® R/F* | High Torque Standard UltraE UltraM |
|  |  | W&H® Roto Quick* | High Torque Standard UltraE UltraM |
|  |  | NSK® Mach/Phatelus®/ FlexiQuick Coupling** | High Torque Standard UltraE UltraM |
|  |    | | Basic & 45° Basic |

Note: TwinPower Turbine 45 is available only in Morita and KaVo® type. TwinPower Turbine Basic and 45 Basic are only available with 4-Hole connection.

| Specifications |  Ceramic ball bearing handpiece | | | |  Push-button chuck | | | |
|----------------------|--|------------------|-------------------------|-------------------------|---|-------------------------|--------------|-------------------------|
| | High Torque | Standard | UltraE | UltraM | 45° | 45° Non-Optic | Basic | 45° Basic |
| Model | High Torque | Standard | UltraE | UltraM | 45° | 45° Non-Optic | Basic | 45° Basic |
| Power | 25 W | 22 W | 20 W | 18 W | 20 W | 20 W | 22 W | 20 W |
| Rotation speed | 370,000 rpm ± 30,000 rpm (at 0.2 MPa/29 psi) | | | | | | | |
| Air/Water ports | Air/Water: 3 | Air/Water: 3 | Chip air: 3 Water: 3 | Chip air: 5 Water: 1 | Chip air: 0 Water: 3 | Chip air: 0 Water: 3 | Air/Water: 3 | Chip air: 0 Water: 3 |
| Head diameter | 12 mm | 10.5 mm | 9.0 mm | 9.0 mm | 10.5 mm | 10.5 mm | 10.5 mm | 10.5 mm |
| Head height | 13.2 mm | 13.2 mm | 12.7 mm | 10.6 mm | 13.2 mm | 13.2 mm | 13.2 mm | 13.2 mm |
| Body/Coating | Ceramic coating | Ceramic coating | Ceramic coating | Ceramic coating | Ceramic coating | Ceramic coating | Chrome | Chrome |
| Optics | Glass rod optics | Glass rod optics | Glass rod optics | Glass rod optics | Glass rod optics | None | None | None |
| Light intensity | 25,000 LUX | 25,000 LUX | 25,000 LUX | 25,000 LUX | 25,000 LUX | NA | NA | NA |
| Weight* | 48 - 57 g | 48 - 57 g | 48 - 57 g | 48 - 57 g | 53 - 59 g | 50 - 56 g | 45 g | 45 g |
| Driving air pressure | 0.2 – 0.29 MPa/29 - 42 psi | | | | | | | |
| Warranty | 2 years | 2 years | 2 years | 2 years | 2 years | 2 years | 1 year | 1 year |

* Weight varies depending on connection type

Ordering Information

TwinPower Turbine High Torque



| | |
|------------|---|
| 16-5339049 | TwinPower Turbine 4H PAR-4HX-O (TwinPower Morita) |
| 16-5901111 | TwinPower Turbine 4H PAR-4HX-O-KV (KaVo® MULTIflex® LUX*) |
| 16-5901154 | TwinPower Turbine 4H PAR-4HX-O-SR (Sirona® R/F*) |
| 16-5901146 | TwinPower Turbine 4H PAR-4HX-O-WH (W&H® Roto Quick*) |
| 16-5901138 | TwinPower Turbine 4H PAR-4HX-O-NK (NSK® FlexiQuick**) |

TwinPower Turbine Standard



| | |
|------------|--|
| 16-5340888 | TwinPower Turbine 4H PAR-4HEX-O (TwinPower Morita) |
| 16-5340608 | TwinPower Turbine 4H PAR-4HEX-O-KV (KaVo® MULTIflex® LUX*) |
| 16-5340632 | TwinPower Turbine 4H PAR-4HEX-O-SR (Sirona® R/F*) |
| 16-5340624 | TwinPower Turbine 4H PAR-4HEX-O-WH (W&H® Roto Quick*) |
| 16-5340616 | TwinPower Turbine 4H PAR-4HEX-O-NK (NSK® FlexiQuick**) |

TwinPower Turbine UltraE (Mini)



| | |
|------------|---|
| 16-5356970 | TwinPower Turbine 4H PAR-4HUEX-O (TwinPower Morita) |
| 16-5357497 | TwinPower Turbine 4H PAR-4HUEX-O-KV (KaVo® MULTIflex® LUX*) |
| 16-5357527 | TwinPower Turbine 4H PAR-4HUEX-O-SR (Sirona® R/F*) |
| 16-5357519 | TwinPower Turbine 4H PAR-4HUEX-O-WH (W&H® Roto Quick*) |
| 16-5357500 | TwinPower Turbine 4H PAR-4HUEX-O-NK (NSK® FlexiQuick**) |

TwinPower Turbine UltraM (Mini)



| | |
|------------|---|
| 16-5356989 | TwinPower Turbine 4H PAR-4HUMX-O (TwinPower Morita) |
| 16-5357578 | TwinPower Turbine 4H PAR-4HUMX-O-KV (KaVo® MULTIflex® LUX*) |
| 16-5357608 | TwinPower Turbine 4H PAR-4HUMX-O-SR (Sirona® R/F*) |
| 16-5357594 | TwinPower Turbine 4H PAR-4HUMX-O-WH (W&H® Roto Quick*) |
| 16-5357586 | TwinPower Turbine 4H PAR-4HUMX-O-NK (NSK® FlexiQuick**) |

TwinPower Turbine 45 and TwinPower Turbine 45 Non-Optic (45°)



| | |
|------------|---|
| 16-5344670 | TwinPower Turbine (With Optics) 4H PAR-4HEX-O-45 (TwinPower Morita) |
| 16-5350522 | TwinPower Turbine (With Optics) 4H PAR-4HEX-O-KV-45 (KaVo® MULTIflex® LUX*) |
| 16-5361087 | TwinPower Turbine (Non-Optic) 4H PAR-4HEX-45 (TwinPower Morita) |
| 16-5361079 | TwinPower Turbine (Non-Optic) 4H PAR-4HEX-KV-45 (KaVo® MULTIflex® LUX*) |

TwinPower Turbine Basic



| | |
|------------|--|
| 16-5360838 | TwinPower Turbine 4H PAR-4HEX-B (4-Hole) |
|------------|--|

TwinPower Turbine 45 Basic (45°)



| | |
|------------|---|
| 16-5606322 | TwinPower Turbine 4H PAR-4HEX-B-45 (4-Hole) |
|------------|---|

TwinPower Morita Coupling Options



| | |
|------------|---|
| 16-5354978 | TwinPower coupling CP4-LD (with LED light) |
| 16-5354951 | TwinPower coupling CP4-W-LD (with water adjustment & LED light) |
| 16-5333830 | TwinPower coupling CP4-O (with light) |
| 16-5339421 | TwinPower coupling CP4-WO (with water adjustment & light) |
| 16-5333881 | TwinPower coupling CP4 (without light) |
| 16-5349214 | TwinPower coupling CP5-O (with optics) |

* KaVo MULTIflex LUX is a registered trademark of Kaltenbach & Voigt GmbH. Sirona is a registered trademark of Sirona Dental Systems GmbH. W&H and Roto Quick are registered trademarks of W&H Dental Bürmoos GmbH.

** NSK and Phatelus are registered trademarks of NAKANISHI INC. Name of coupling varies by country.

Diagnostic and Imaging Equipment

Treatment Units

Handpieces & Instruments

Endodontic Systems

Laser Equipment

Laboratory Devices

Educational and Training Systems

Auxiliaries

Distributed by

J. Morita USA, Inc.

9 Mason Irvine, CA 92618 U.S.A.
Tel: 1-949-581-9600, Fax: 1-949-465-1095
www.morita.com/usa

Developed and Manufactured by

J. Morita Mfg. Corp.

680 Higashihama Minami-cho, Fushimi-ku, Kyoto, 612-8533 Japan
Tel: +81-75-611-2141, Fax: +81-75-622-4595

J. Morita Corporation

33-18, 3-Chome, Tarumi-cho Suita City, Osaka, 564-8650 Japan
Tel: +81-6-6380-1521, Fax: +81-6-6380-0585

J. Morita Europe GmbH

Justus-von-Liebig-Strasse 27A, D-63128 Dietzenbach, Germany
Tel: +49-6074-836-0, Fax: +49-6074-836-299

Siamdent Co., Ltd.

444 Olympia Thai Tower, 3rd Floor, Ratchadapisek Road, Samsennok,
Huay Kwang, Bangkok 10310, Thailand
Tel: +66-2-512-6049, Fax: +66-2-512-6099
www.siamdent.com

J. Morita Corporation Australia & New Zealand

Suite 2.05, 247 Coward Street, Mascot, NSW 2020, Australia
Tel: +61-2-9667-3555, Fax: +61-2-9667-3577

J. Morita Middle East

4 Tag Al Aoasaa, Saba Pacha 21311, Alexandria, Egypt
Tel: +203-58-222-94, Fax: +203-58-222-96

Morita Global Website: www.morita.com